

BENDING RESISTANCE OF METAL-CONCRETE COMPOSITE BEAMS IN A NATURAL FIRE

Marcin CHYBIŃSKI, Łukasz POLUS¹

Faculty of Civil and Environmental Engineering, Poznan University of Technology,
Poznań, Poland

Abstract

In this paper, the bending resistance of three metal-concrete composite beams was compared in real car fires in an open car park. Steel and concrete composite beams are often used for the construction of ceilings in multi-storey car parks. The authors made an attempt to evaluate how the replacement of a non-alloy steel girder with a stainless steel or aluminium alloy girder affects the bending resistance of a composite beam under fire conditions. The analysed beams were not fire-protected. They consisted of a concrete slab and a girder made of: non-alloy (*carbon*) S235J2 (1.0117) steel, X6CrNiMoTi17-12-2 (1.4571) stainless steel, and AW-6061 T6 (EN AW-Al Mg1SiCu) aluminium alloy.

Keywords: composite beams, fire, steel, stainless steel, aluminium alloy, open car park

1. INTRODUCTION

Steel and concrete composite structures are often used for the construction of open car parks. Composite beams consist of steel girders and concrete slabs. Girders are connected with the concrete slabs by shear connections as presented in [1-3]. Most often, the girders are made of non-alloy steel and need anti-corrosion coatings. To reduce the cost of corrosion-resistant coatings, the girders

¹Corresponding author: Poznan University of Technology, Institute of Structural Engineering, Faculty of Civil and Environmental Engineering, ul. Piotrowo 5, 60-965 Poznan, Poland, e-mail: lukasz.polus@put.poznan.pl, tel. +48616652098

may be made of stainless steel or aluminium alloy [4-6]. These solutions need thorough analyses.

1.1. A stainless steel beam as a girder for a composite beam

A stainless steel girder may improve steel-concrete constructions because stainless steel has high corrosion resistance and fire resistance compared to non-alloy steel and does not need any corrosion-resistant coating [7]. Chromium and nickel have the greatest impact on the thermal properties of stainless steel [8]. Austenitic stainless steel has the best combination of strength and oxidation resistance. Ellobody analysed a composite slim floor stainless steel beam construction exposed to fires [9]. The study demonstrated that the composite slim floor stainless steel beam construction provides a considerable increase in fire resistance.

The high cost of stainless steel is an important problem. However, analysis of the whole-life cost of constructions with stainless steel can reveal the use of such steel as more favourable [10].

1.2. An aluminium beam as a girder for a composite beam

Aluminium as a structural material has many advantages, e.g. light weight, high strength-to-weight ratio, and excellent corrosion resistance [11]. Due to its light weight, the erection phases are simple [12, 13]. Steel may become brittle at low temperatures, whereas aluminium is resistant to brittle failure [14] and can be used in cold environments [15]. There are many aluminium alloys whose mechanical properties depend on the type of treatment, welding, and content of alloying elements [16]. Different kinds of reinforcement may be infused into the aluminium matrix in order to improve hardness, toughness, stiffness, wear resistance, fatigue properties, electrical properties, and thermal stability [17]. The joining of aluminium and concrete in composite beams is not the only possibility. Chen et al. analysed CFRP strengthened concrete-filled aluminium alloy CHS tubes [18].

However, aluminium is more expensive than non-alloy steel, e.g., 1 kg of I-beam made of AW-6060 aluminium alloy cost 3.2 € in 2016 [19]. This could be partially offset by lower maintenance costs [20]. Furthermore, most of the aluminium alloys start to lose some strength when exposed to temperatures exceeding 100 °C [21]. The alloys in an H and T hardening state exhibit a relevant loss of strength with temperature (70-80 % at 250 °C). The alloys in the annealed O state show a less significant loss of strength (30-50 % at 250 °C) [22]. Moreover, significant stresses evoked by the temperature change may appear in the aluminium-concrete composite beam because aluminium and concrete have different coefficients of thermal expansion [23].

2. PROBLEM FORMULATION

Composite steel-concrete beams are used for a variety of purposes. The use of composite beams with a girder made of an aluminium alloy or stainless steel instead of a non-alloy steel should be carefully considered. The economical, structural, and fire analyses should be prepared before the use of non-standard composite beams. The fire resistance requirements for open car parks based on the standard ISO 834 curve are rather high. For this reason, it is worth analysing the behaviour of structures in real car fires [24]. The use of natural fire models may provide for a reduction of the costs of fire protection materials, because the temperature of structural elements tends to be lower in a natural fire than in a standard fire, which was the case for the steel column analysed in [25] or the composite concrete filled tubular columns analysed in [26]. The use of the natural fire approach provides for a more realistic design, which should be both safe and reliable [27]. Szymkuć et al. analysed the performance of concrete filled tubular columns during ISO and localised fire in an open car park [28]. It was shown that the maximum temperatures were below 400°C on the steel tube surface and between 100 and 200 °C inside the column.

This paper presents an analysis of the bending resistance of metal-concrete composite beams in a natural fire. The authors of this article used a performance-based approach [29] with application of the natural fire concept and analysed an open car park where composite structures were used. Based on car fire tests and research, one scenario was chosen – three cars in a line [30, 31] (see Fig. 1). The fire started with car no.1 and spread out to the two remaining cars after 12 minutes [30]. This spread time value is rather conservative. However, in the case of cars parked 40 and 60 cm away from each other, the fire may spread faster [32]. The intensity of the fire was represented by the rate of heat release (RHR). The RHR curves were taken from the tests presented in [30] (see Fig 2).

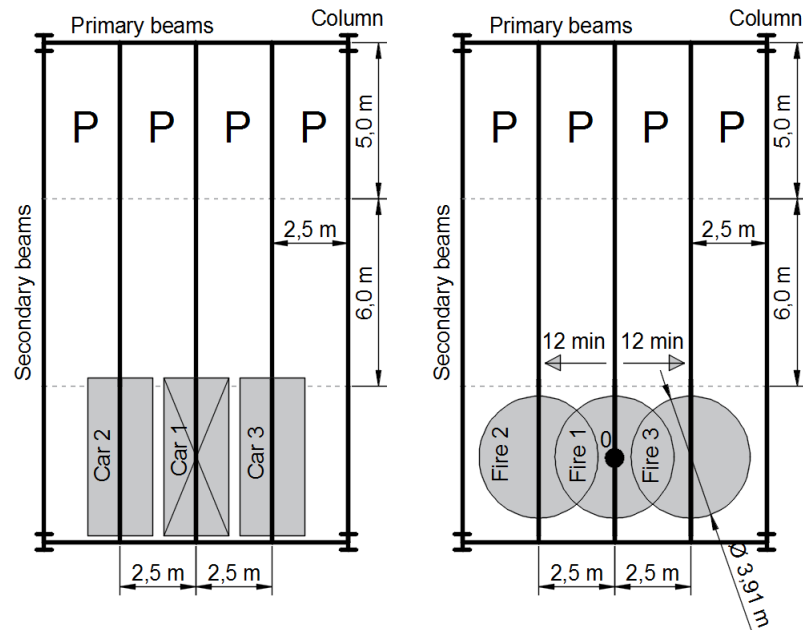

Fig. 1. Fire scenario – three cars in a line

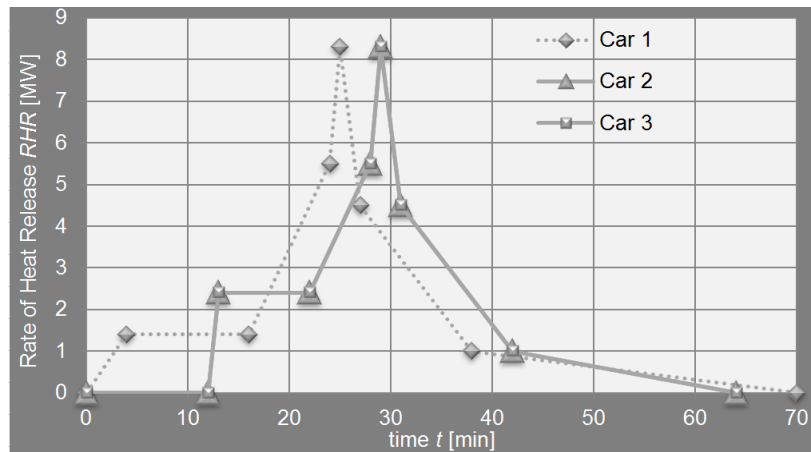

Fig. 2. Rate of heat release for each of the three cars

The authors of this article analysed three composite beams. The beams consisted of a concrete slab made of C30/37 concrete and a metal girder made of non-alloy steel (S235J2), stainless steel (X6CRNIMOTI17-12-2) or aluminium alloy (AW-6061 T6). The girders were made of metals, which had similar yield strengths, and which can be used to prepare I-section beams. To analyse the bending

resistance of the composite metal-concrete beams the following assumptions were made:

- car fires were used to heat up the composite beams;
- a simplified calculation method presented in Annex E in [33] was used to evaluate the resistance of the member under fire conditions;
- the composite beams were simply supported, subjected to bending (sagging moment) and exposed to fire beneath the concrete slab;
- there was full-composite connection between the metal girder and the concrete slab;
- the temperature of the concrete layers in compression was below 250 °C;
- the composite beams had class 1 or 2 cross-sections;
- the rise in temperature of the unprotected metal beam parts was determined using the method presented in [33], the time interval Δt was 3 s, and the gas temperature obtained from the car fires was used to heat up the composite beams.

The cross-section of the analysed composite beams and the model used to calculate the sagging moment resistance are presented in Figure 3. This model was also used by Kruppa and Zhao [34] who demonstrated that the strength of the steel section had the greatest impact on the fire resistance of the composite beams. The model was prepared for the analysis of the single structural element [35]. The fire resistance of the composite beams may depend on shear connections [36]. In this paper it was assumed that there was a full-composite connection between the metal girder and the concrete slab.

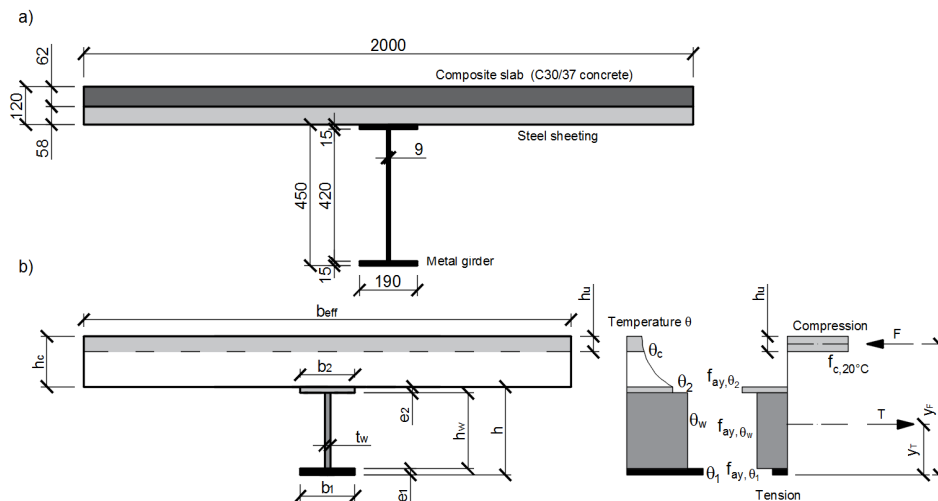

Fig. 3. a) The cross-section of the analysed composite beams, b) The model used to calculate the sagging moment resistance

3. CALCULATIONS AND RESULTS

The gas temperature was calculated using the Elefir-EN program [37]. The gas temperatures in the fires of one car and three cars were compared with the gas temperature in the standard fire (see Fig. 4).

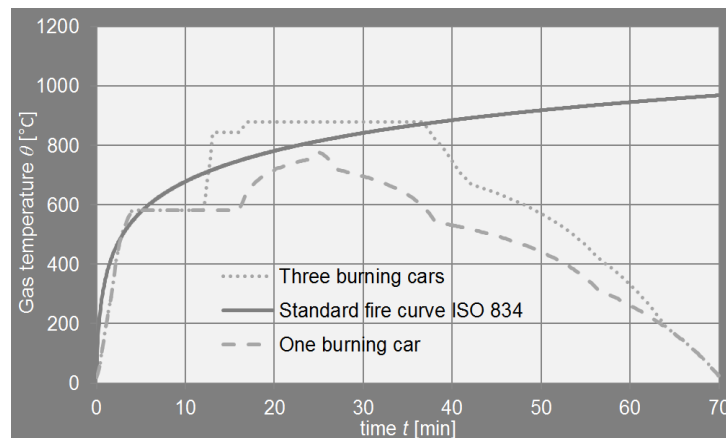

Fig. 4. Gas temperatures

The data used to calculate the bending resistance of the composite beams under fire conditions and the calculations of said resistance are presented in Tables 1-4. The specific heat values for analysed metals are presented in Fig. 5.

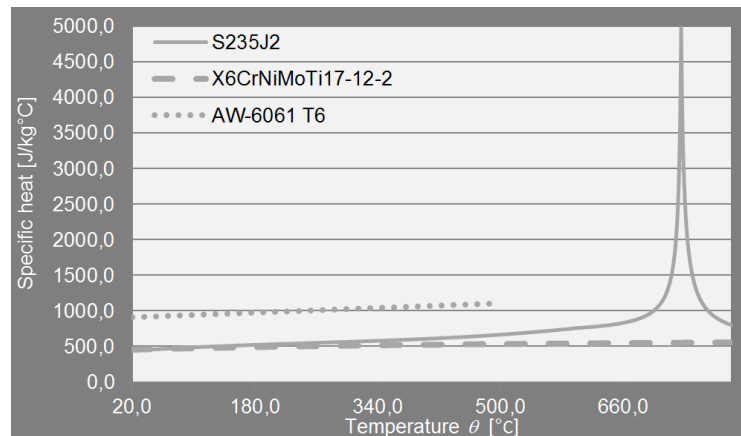

Fig. 5. Specific heat for the analysed metals

The rise in temperature of unprotected metal beams parts was determined every 3 seconds ($\Delta t = 3$ s). It was assumed that the temperature of the web was equal to that of the lower flange. This simplification was presented in [33] and may be

used if the beam depth h does not exceed 500 mm. The reduction factors for yield strength were taken from [38, 39] and are presented in Figure 6.

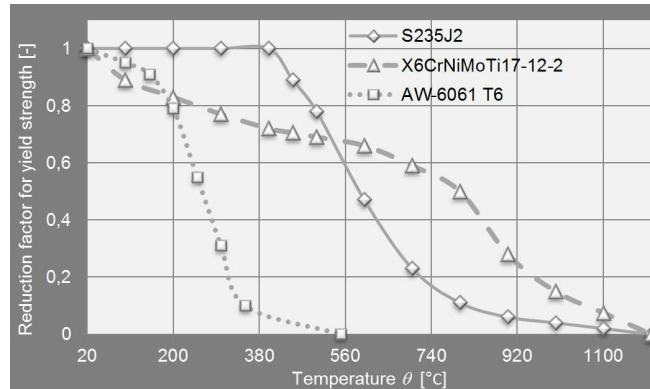

Fig. 6. Reduction factors for yield strength

Table 1. Data used in the calculations

Parameter	Value
Width of the lower flange b_l [mm]	190.0
Thickness of the lower flange e_l [mm]	15.0
Width of the upper flange b_2 [mm]	190.0
Thickness of the upper flange e_2 [mm]	15.0
Height of the web h_w [mm]	420.0
Thickness of the web e_w [mm]	9.0
Effective width of the concrete slab b_{eff} [mm]	2000.0
Thickness of the concrete slab above the steel sheeting h_c [mm]	62
Height of the steel sheeting h_p [mm]	58
Height of the girder h [mm]	450
Design value of the compressive strength of concrete f_{cd} [MPa]	21.4
Design value of the yield strength of S235J2 (1.0117) steel f_{yd} [MPa]	235.0
Design value of the yield strength of X6CrNiMoTi17-12-2 (1.4571) steel f_{od} [MPa]	218.2
Design value of the yield strength of AW-6061 T6 (EN AW-Al Mg1SiCu) aluminium alloy f_{od} [MPa]	181.8
Density of steel ρ [kg/m ³]	7850.0
Density of aluminium ρ [kg/m ³]	2700.0
Emissivity coefficient of S235J2 (1.0117) steel ε_m [-]	0.7
Emissivity coefficient of X6CrNiMoTi17-12-2 (1.4571) steel ε_m [-]	0.4
Emissivity coefficient of AW-6061 T6 (EN AW-Al Mg1SiCu) aluminium alloy ε_m [-]	0.3
Emissivity coefficient of the fire ε_f [-]	1.0
Convective heat transfer coefficient α_c [W/(m ² K)]	35.0

Time interval Δt [s]	3.0
Correction factor for the shadow effect k_{shadow} [-]	0.68
Section factor for the lower flange A_1/V_1 [1/m]	143.9
Section factor for the upper flange A_2/V_2 [1/m]	77.2

Table 2. Calculations of the bending resistance of a composite beam with the S235J2 (1.0117) steel girder

Parameter	Time t [min]			
	0	10	20	30
Temperature of the lower flange θ_l [°C]	20	366.5	735.3	865
Temperature of the upper flange θ_2 [°C]	20	242	602.2	744.1
Reduction factors for the yield strength of the lower flange k_θ [-]	1.0	1.0	0.27	0.08
Reduction factors for the yield strength of the upper flange k_θ [-]	1.0	1.0	0.46	0.30
Design value of the yield strength of the upper flange f_{av,θ_1} [MPa]	235.0	235.0	63.5	18.8
Design value of the yield strength of the lower flange f_{av,θ_2} [MPa]	235.0	235.0	108.1	70.5
Tensile force T [kN]	2227.8	2227.8	728.8	325.6
Location of the tensile force y_T [mm]	225.0	225.0	263.0	323.4
Thickness of the compressive zone h_u [mm]	62.4	62.4	20.4	9.1
Location of the compression force y_F [mm]	480.8	480.8	501.8	507.4
Bending resistance $M_{f,Rd}$ [kNm]	569.9	569.9	174.0	59.9

Table 3. Calculations of the bending resistance of the composite beam with the X6CrNiMoTi17-12-2 (1.4571) steel girder

Parameter	Time t [min]			
	0	10	20	30
Temperature of the lower flange θ_l [°C]	20	319.5	733.3	863.7
Temperature of the upper flange θ_2 [°C]	20	204.6	527.7	752.4
Reduction factors for the yield strength of the lower flange k_θ [-]	1.0	0.76	0.56	0.36
Reduction factors for the yield strength of the upper flange k_θ [-]	1.0	0.83	0.68	0.54
Design value of the yield strength of the upper flange f_{av,θ_1} [MPa]	181.8	138.2	101.8	65.5
Design value of the yield strength of the lower flange f_{av,θ_2} [MPa]	181.8	195.1	159.8	126.9
Tensile force T [kN]	1723.5	1472.0	1130.5	795.6
Location of the tensile force y_T [mm]	225.0	248.9	256.8	272.9
Thickness of the compressive zone h_u [mm]	48.3	41.2	31.7	22.3
Location of the compression force y_F [mm]	487.9	491.4	496.2	500.9
Bending resistance $M_{f,Rd}$ [kNm]	453.0	356.9	270.6	181.4

Table 4. Calculations of the bending resistance of the composite beam with the AW-6061 T6 (EN AW-Al Mg1SiCu) aluminium alloy girder

Parameter	Time t [min]			
	0	5	10	15
Temperature of the lower flange θ_1 [°C]	20	191.4	375.8	580.7
Temperature of the upper flange θ_2 [°C]	20	119.7	250.3	410.4
Reduction factors for the yield strength of the lower flange k_{θ} [-]	1.0	0.81	0.09	0.0
Reduction factors for the yield strength of the upper flange k_{θ} [-]	1.0	0.93	0.6	0.1
Design value of the yield strength of the upper flange f_{av,θ_1} [MPa]	218.2	190.4	21.2	0.0
Design value of the yield strength of the lower flange f_{av,θ_2} [MPa]	218.2	218.6	129.3	16.5
Tensile force T [kN]	2068.5	1884.9	508.6	46.9
Location of the tensile force y_T [mm]	225.0	234.3	356.8	442.5
Thickness of the compressive zone h_u [mm]	57.9	52.8	14.2	1.3
Location of the compression force y_F [mm]	483.0	485.6	504.9	511.3
Bending resistance $M_{f,Rd}$ [kNm]	533.8	473.7	75.3	3.2

The comparison of the bending resistance of the composite beams in the car fires is presented in Figure 7. After 15 minutes, the bending resistance of the aluminium-concrete composite beam decreased by 99.4 %, the bending resistance of the steel-concrete composite beam with the S235J2 (1.0117) steel girder decreased by 42.3 %, and the bending resistance of steel-concrete composite beam with the X6CrNiMoTi17-12-2 (1.4571) steel girder decreased by 28.9 %. The strength of the metal section had the greatest impact on the fire resistance of the composite beams. Due to the fact that the AW-6061 T6 (EN AW-Al Mg1SiCu) aluminium alloy in H hardening state exhibited a relevant loss of strength as the temperature increased, the bending resistance of the aluminium-concrete composite beam decreased rapidly. The X6CrNiMoTi17-12-2 (1.4571) steel exhibited a slight loss of strength as the temperature increased, due to its chemical composition.

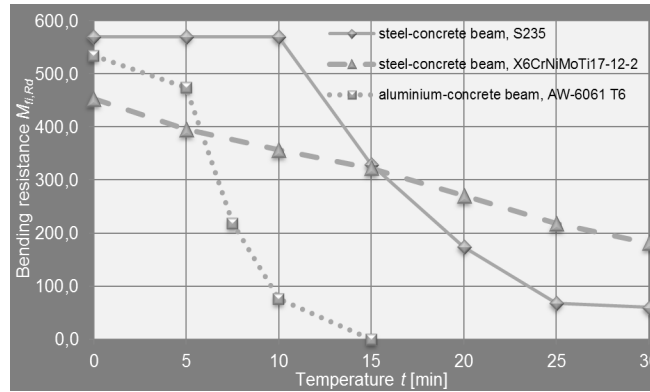

Fig. 7. Bending resistance of the composite beams in the tree-car fire

The X6CrNiMoTi17-12-2 (1.4571) steel is austenitic stainless steel and can be used in the marine environment, e.g. in offshore structures and in pressure vessels. Designers may use plates, sheets or bars made of said steel. Bric et al. investigated the mechanical properties of the X6CrNiMoTi17-12-2 (1.4571) steel at low and elevated temperatures [40]. They demonstrated that the ultimate tensile strength and the 0.2% offset yield strength of said steel decreased slightly with a rise in temperature. Table 5 presents the chemical composition of the analysed steel.

Table 5. Chemical composition of S235J2 and X6CrNiMoTi17-12-2 steel [41, 42]

EN 10027-1	EN 10027-2	C	Si	Mn	P	S
S235J2	1.0117	≤ 0.17	-	≤ 1.40	≤ 0.025	≤ 0.025
X6CrNiMoTi17-12-2	1.4571	≤ 0.08	≤ 1.0	≤ 2.0	≤ 0.045	≤ 0.015
		Cu	Cr	Mo	Ni	Ti
S235J2	1.0117	≤ 0.55	-	-	-	-
X6CrNiMoTi17-12-2	1.4571	-	16.5÷18.5	2.0÷2.5	10.5÷13.5	5×C÷0.70

The X6CrNiMoTi17-12-2 (1.4571) steel contains molybdenum, nickel, chrome, and a small amount of titanium. Steel is heat-resistant at temperature below 650 °C when it contains 5 % chrome and at temperature below 1100 °C when it contains 30 % chrome. Nickel (> 9%) combined with chrome (about 18 %) improves creep resistance.

4. CONCLUSIONS

This article discussed the results of the analysis of the bending resistance of composite beams in a three-car fire. The authors came to the following conclusions:

- The strength of the metal section had the greatest impact on the fire resistance of the composite beams.
- The bending resistance of the aluminium-concrete composite beam decreased to 0.0 kNm rapidly in the fire conditions.
- The steel-concrete composite beam with the girder made of X6CrNiMoTi17-12-2 (1.4571) steel exhibited a slight loss of bending resistance as the temperature increased, due to the chemical composition of said steel.

REFERENCES

1. Biegus A., Lorenc W.: *Development of shear connections in steel-concrete composite structures*, Civil And Environmental Engineering Reports, **15**, 4 (2014) 23-32.
2. Polus Ł., Szumigała M.: *Tests of shear connectors used in aluminium-concrete composite structures*, in: Recent Progress in Steel and Composite Structures, edit. M. Giżejowski, A. Kozłowski, J. Marcinowski, J. Ziółko, Boca Raton, CRC Press-Taylor & Francis Group 2016, 133-136.
3. Koziół P.: *Modern design of steel-concrete composite structures*, Zeszyty Naukowe Politechniki Częstochowskiej, Budownictwo, **21** (2015) 118-127.
4. Polus Ł., Chybiński M., Szumigała M.: *Nośność na zginanie belek zespolonych metalowo-betonowych w warunkach pożaru standardowego*, Przegląd Budowlany, **7-8** (2018) 128-132 [in Polish].
5. Szumigała M., Polus Ł.: *Applications of aluminium and concrete composite structures*, Procedia Engineering, **108** (2015) 544-549.
6. Szumigała M., Polus Ł.: *An numerical simulation of an aluminium-concrete beam*, Procedia Engineering, **172** (2017) 1086-1092.
7. Lam D., Gardner L.: *Structural design of stainless steel concrete filled columns*, Journal of Constructional Steel Research, **64** (2008) 1275-1282.
8. Gardner L., Insausti A., Ng K. T., Ashraf M.: *Elevated temperature material properties of stainless steel alloys*, Journal of Constructional Steel Research, **66**, 5 (2010) 634-647.
9. Ellobody E.: *Composite slim floor stainless steel beam construction exposed to different fires*, Engineering Structures, **36** (2012) 1-13.
10. Gardner L., Cruise R. B., Sok C. P., Krishnan K., Ministro dos Santos J.: *Life cycle costing of metallic structures*, Proceedings of the Institution of Civil Engineers – Engineering Sustainability, **60**, 4 (2007) 166-177.
11. Das S. K., Kaufman J. G.: *Aluminum alloys for Bridges and bridge decks*, in: Aluminum alloys for transportation, packaging, aerospace, and other applications, edit. K. D. Subodh, W. Yin W., The Minerals, Metals and Materials Society 2017, 61-72.

12. Mazzolani F. M.: *Structural Applications of Aluminium in Civil Engineering*, Structural Engineering International, **16**, 4 (2006) 280-285.
13. Kossakowski P., Wciślik W., Bakalarz M.: *Selected aspects of application of aluminium alloys in building structures*, Structure and Environment, **9**, 4 (2017) 256-263.
14. Dokšanović T., Džeba I., Markulak D.: *Applications of aluminium alloys in civil engineering*, Technical Gazette, **24**, 5 (2017) 1609-1618.
15. Kossakowski P.: *Aluminium alloys as structural material in bridges*, Zeszyty Naukowe Politechniki Częstochowskiej, Budownictwo, **22** (2016) 159-170.
16. Dokšanović T., Džeba I., Markulak D.: *Variability of structural aluminium alloys mechanical properties*, Structural Safety, **67** (2017) 11-26.
17. Moona G., Walia R. S., Rastogi V., Sharma R.: *Aluminium metal matrix composites: A retrospective investigation*, Indian Journal of Pure & Applied Physics, **56** (2018) 164-175.
18. Chen Y., Ran F., Xu J.: *Flexural behaviour of CFRP strengthened concrete-filled aluminium alloy CHS tubes*, Construction and Building Materials, **142** (2017) 295-319.
19. Szumigała M., Chybiński M., Polus Ł.: *Preliminary analysis of the aluminium-timber composite beams*, Civil and Environmental Engineering Reports, **27**, 4 (2017) 131-141.
20. Siwowski T.: *Aluminium Bridges – Past, Present and Future*, Structural Engineering International, **16**, 4 (2006) 286-293.
21. Tindal P.: *Aluminium in bridges*, in: ICE Manual of Bridge Engineering, edit. G. Parke, N. Hewson, Institution of Civil Engineers 2008, 345-355.
22. Faggiano B., De Matteis G., Landolfo R., Mazzolani F. M.: *Behaviour of aluminium alloy structures under fire*, Journal of Civil Engineering and Management, **10**, 3 (2004) 183-190.
23. Marcinowski J.: *Stresses in a layered, composite structure fabricated from materials of different thermal expansions*, Materiały Budowlane, **4** (2018) 107-109.
24. EN 1991-1-2 Eurocode 1: Actions on structures - Part 1-2: General actions – Actions on structures exposed to fire.
25. Szumigała M., Polus Ł.: *A comparison of the rise of the temperature of an unprotected steel column subjected to the standard fire curve ISO 834 and to a natural fire model in the office*, Engineering Transactions, **63**, 2 (2015) 157-170.
26. Szymkuć W., Glema A., Malendowski M.: *Fire performance of composite concrete filled tubular columns exposed to localized fire*, in: Advances in Mechanics: Theoretical, Computational and Interdisciplinary, Proceedings of the 3rd Polish Congress of Mechanics (PCM) and 21st International

- Conference of Computer Methods in Mechanics (CMM), edit. M. Kleiber et al. [Eds.], CRC Press 2016, 573-576.
27. Malendowski M., Glema A.: *Development and Implementation of Coupling Method for CFD-FEM Analyses of Steel Structures in Natural Fire*, *Procedia Engineering*, **172** (2017) 692-700.
 28. Szymkuć W., Glema A., Malendowski M., Mielcarek A., Smardz P., Poteralski A.: *Numerical investigation of fire and post-fire performance of CFT columns in an open car park fire*, in: SiF 2018 – The 10th International Conference on Structures in Fire, FireSert, Ulster University in Belfast, June 6-8, 2018.
 29. Zhao B., Kruppa J.: *Structural behavior of an open car park under real fire scenarios*, *Fire and materials*, **28** (2004) 269-280.
 30. European Commission, *Development of design rules for steel structures subjected to natural fires in closed car parks* (1999).
 31. ArcelorMittal, Building Research Institute (ITB), Poznan University of Technology: *Open Steel Car Parks Design for the Polish Market*, 2011.
 32. Márton T., Dederichs A., Giuliani L.: *Modelling of fire in an open car park*, in: *Proceedings of the International Conference in Dubrovnik, 15-16 October 2015* in edition of *Applications of Structural Fire Engineering*, edit. F. Wald et al., Czech Technical University in Prague, DOI: <https://doi.org/10.14311/asfe.2015.060>, 2017.
 33. EN 1994-1-2 Eurocode 4: Design of composite steel and concrete structures - Part 1-2: General rules – Structural fire design.
 34. Kruppa J., Zhao B.: *Fire resistance of composite beams to Eurocode 4 Part 1.2*, *Journal of Constructional Steel Research*, **33** (1995) 51-69.
 35. Baj A., Łapko A., *Evaluation of structural capacity under fire conditions of steel-concrete composite members according to PN-EN 1994-1-2:2008*, *Budownictwo i Inżynieria Środowiska*, **2** (2011) 115-121 [in Polish].
 36. Huang Z., Burgess I. W., Plank R. J.: *The influence of shear connectors on the behaviour of composite steel-framed buildings in fire*, *Journal of Constructional Steel Research*, **51** (1999) 219-237.
 37. Franssen J. M., Real P. V.: *Fire design of steel structures, Eurocode 1: Actions on structures, Part 1-2: Actions on structures exposed to fire, Eurocode 3: Design of steel structures, Part 1-2: Structural fire design*, ECCS 2010.
 38. EN 1993-1-2 Eurocode 3: Design of steel structures - Part 1-2: General rules – Structural fire design.
 39. EN 1999-1-2 Eurocode 9: Design of aluminium structures - Part 1-2: General rules – Structural fire design.
 40. Brnic J., Turkalj G., Canadija M., Lanc D.: *AISI 316Ti (1.4571) steel*

Mechanical, creep and fracture properties versus temperature, Journal of Constructional Steel Research, **67** (2011) 1948-1952.

41. EN 10088-1:2014, Stainless steels. List of stainless steels.

42. EN 10025-2:2007, European standard for hot-rolled structural steel. Part 2 - Technical delivery conditions for non-alloy structural steels.

NOŚNOŚĆ NA ZGINANIE BELEK ZESPOLONYCH METALOWO-BETONOWYCH W POŻARZE NATURALNYM

Streszczenie

W artykule porównano nośności na zginanie trzech wybranych belek zespolonych metalowo-betonowych w warunkach pożaru samochodów w otwartym garażu. Autorzy próbują ocenić jaki wpływ na nośność zginanej belki zespolonej ma zamiany dźwigara ze stali niestopowej na dźwigar ze stali nierdzewnej lub stopu aluminium. Przeanalizowano niezabezpieczone przed ogniem belki zespolone złożone z betonowej płyty oraz dźwigarów wykonanych z: stali konstrukcyjnej niestopowej S235J2 (1.0117), stali nierdzewnej X6CrNiMoTi17-12-2 (1.4571) lub stopu aluminium AW-6061 T6 (EN AW-Al Mg1SiCu).

Słowa kluczowe: belki zespolone, pożar, stal, stal nierdzewna, stop aluminium, garaż otwarty

Editor received the manuscript 30.10.2018.